



USAGE MANUAL

User Manual of Dental Units

Type: UMG-02H

- Thank for your buying UMG - 02H dental unit
- To ensure sufficient use of all UMG-02H dental unit functions, please read this User Manual carefully
- Please well keep this User Manual and use it as a reference against any issue

Table of Contents

Part 1 Security Information	1
Part 2 Figures & Symbols	2
Part 3 Precautions	2
Part 4 Transport & Storage.....	2
Part 5 Introduction of Products	3
Part 6 Operation Conditions	3
Part 7 Basic Parameters.....	3
Part 8 Structural Diagram	4
Part 9 Installation of Products.....	6
Part 10 Testing.....	9
Part 11 Part 11 Operation Instructions.....	9
1. Instructions for tool tray button panel.....	9
2. Instructions for assistant rack button panel operation.....	11
3. Instructions for water storage tank.....	11
4. Instructions for foot controller use.....	11
5. Instructions for water and air quantity adjustment of handpiece.....	12
6. Instructions for cold-light lamp use.....	12
7. Instructions of film-viewing lamp.....	12
8. Instructions of three-purpose spray gun and saliva sucker.....	12
Part 12 Maintenance.....	13
Part 13 Troubleshooting	13
Part 14 Circuit Diagram.....	14
Part 15 Circuit Diagram of Patient Chair.....	15
Part 16 Water & Air Installation Diagram.....	16
Part 17 Schematic Diagram for Water & Air Routes	17

Part 1 Security Information

Please read this User Manual in order to use the product correctly. If you have any special requirements, please contact our dealers.



1. In order to reduce the possibility of fire and electric shock, don't set the equipment in a damp place; don't open the box. If machine repair is needed, please contact professional maintenance personnel.
2. If smoke or other abnormal status occurs to the unit, it may lead to fire. please immediately disconnect the power, and contact local dealer or after-sales service department.
3. Water entering into the unit may cause electric leakage, please immediately disconnect the power, and contact local dealer or after-sales service department.
4. If any unknown fault occurs to the unit, please immediately disconnect the power, and contact local dealer.
5. Please don't detach or refitted the unit, otherwise or some parts inside may be damaged or cause electric shock.
6. Keep the power cord from damage. If the power cord is damaged, immediately disconnect the power, and don't directly touch the power supply by hand. Please contact the local seller for replacing the damaged wires.
7. The product is suitable for AC 220V working power. if it's used in other voltages, risk may occur.
8. Please be attentive to the weather changes, and disconnect the power in case of lightning weather.
9. Don't touch the power plug with a wet hand, which may cause electric shock.
10. Please don't clean the unit with pesticides, alcohol, diluent and chemical liquids which may result in surface peeling or decay.
11. Please don't restructure the unit. If there is any damage, no repair and warranty will be provided.













To users:

This product has passed tests, conforms to the use requirements. This product is not fitted a Hg separator, therefore the drainage system of the unit can't filter solid particulate or amalgam. We don't guarantee the drained water would cause pollution. User can install a separate Hg separator on the drainage system to avoid the pollution of drained water.

If you want to get detailed information, please contact the manufacturer.

Record the product's serial number here to be convenient for inquiry later!

Part 2 Figures & Symbols

	Warning		Patient chair rise
	Type B apparatus: no electric connection part with patients		Patient chair drop
	Protect ground terminal		Patient chair backing
	Spittoon flush		Patient chair backrest forward
	Mouthwash supply		Patient chair gargle position
	Thermostatic water heater		
	Operation lamp		

Part 3 Precautions

- This product is only used by stomatological department for diagnosis, therapy and operation!
 - Please only use the fuse and accessories recognized by the Company!
 - This product contains electric mechanical moving parts, ensuring it won't touch any objects in its range of work motion!
 - When this product is not used, please drop be patient chair to the lowest position, and disconnect the water, air and power supplies!
 - Before using the patient chair, please confirm the pillow is locked!
 - Don't use the product in high temperature, high humidity, vibration, flammable and imbalanced environments!
 - The patient chair of this product belongs to the intermittent running equipment, shall not continuously run for over 1 minutes!
 - Before using the handpiece, please refer to its operation instruction!
 - For the use of light curing and scaler, please refer to the instructions for use!
- Water supply must be turned on before using the water heater so as to prevent short circuit due to burning in water absene!
- The equipment needed to repair or maintenance, and professional repair personnel, repair broken before boiling water, air, power supply!
- When the apparatus is not used for a long time, be sure to disconnect the water, air and power!
 - It's proposed the service period of the dental unit is five years. exceeding the time limit may result in pipeline aging, function failure, and even accidents. please contact a qualified medical apparatus recycle unit for replacement of the apparatus.

Part 4 Transport & Storage

1. Transport conditions: upward, handle with care, moisture proof.
2. Transport environment: temperature 5~ 40°C, relative humidity ≤80%.
3. Wooden box transport or storage, shall not stack for more than two boxes.

Part 5 Introduction of Products

Spec.:	UMG-02Hdental unit
Safety type:	Type I
Protection type:	Type B
Power type:	Single phase, three cores, power grid supply
Voltage:	a.c.220V
Frequency:	50Hz
Input power:	1200VA

※ This product has application part, no signal input or output portion, belongs to a non-movable apparatus.

This product is a dental unit specially produced and provided for qualified personnel in dentistry clinical and related operating steps, composed of a complete set of interconnected dental apparatuses and components, can be used for dental diagnosis, therapy and operation. This product is mainly composed of a dental patient chair, mouth lamp, instrument tray, three-purpose gun, gargle supply device, saliva sucker, spittoon, film-viewing lamp and foot switch.

Part 6 Operation Conditions

To ensure the normal use of the unit, the input water, air, electricity and working environmental parameters are as follows:

1. Air source: air pressure 0.6MPa ~ 0.80Mpa, flow > 50L / min, oil free
- 2:0.20MPa ~ 0.40MPa, water pressure flow > 10L / min <25 degrees of hardness
- 3: a.c.220V / 50Hz10A, power supply
4. Environment: temperature5~40℃, relative humidity 30%~75%

Part 7 Basic Parameters

- High-speed air turbine hand-piece no-load speed (pressure 0.22Mpa) $\geq 35 \times 10^4 \text{r/min}$
- Low-speed air motor hand-piece no-load speed (pressure 0.30Mpa) $\geq 18 \times 10^3 \text{r/min}$
- Oral LED lamp illumination weak light $\geq 8000 \text{ lx}$, bright light $\geq 15000 \text{ lx}$
- Film viewing lamp illuminance $\geq 2000 \text{ lx}$
- Dental patient chair's loading capacity $\geq 1764 \text{ N}$ (180 Kg)
- Tool tray loading capacity $\leq 5 \text{ Kg}$

- Max. seat cushion height from ground $\geq 700 \text{ mm}$
- Min. seat cushion height from ground $\leq 500 \text{ mm}$
- Scope of backrest tilt: $105^\circ \sim 170^\circ$
- Scope of head frame stretch 120mm
- Max. seat cushion tilt angle $\geq 12^\circ$
- Temperature of constant-temp. water heater $40^\circ \text{C} \pm 5^\circ \text{C}$
- Work space Length $\geq 4000 \text{ mm}$ / width = 2600mm/ height $\geq 2000 \text{ mm}$



UMG-02H

- | | | | | |
|----------------------|-----------------------------|---------------------------|---------------------------|------------------------------------|
| 1. Housing | 2. Seat cushion | 3. Backrest | 4. Pillow | 5. Assistant rack |
| 6. Weak suction | 7. Strong suction | 8. Box | 9. Spittoon | 10. Lamp arm |
| 11. Cold-light | 12. Front rotary | 13. Back rotary arm | 14. Film viewing lamp | 15. Tool tray |
| 16. Tool tray handle | 17. Tool tray control board | 18. Low-speed handpiece | 19. High-speed handpiece | 20. Three-purpose gun (cold water) |
| 21. Armrest | 22. Front housing | 23. Upper balance housing | 24. Lower balance housing | 25. Bottom housing |

I. Installation space

1. Environment requirements

To ensure normal work of the product, please install it in clean, dry and ventilated place, and ensure the ground is flat and solid.

2. Space requirements

In order to ensure the product will not contact any goods in its working scope, the installation space must conform to the following requirements:

- a) Length no less than 4000mm;
- b) Width no less than 2600mm;
- c) Height no less than 2000mm.

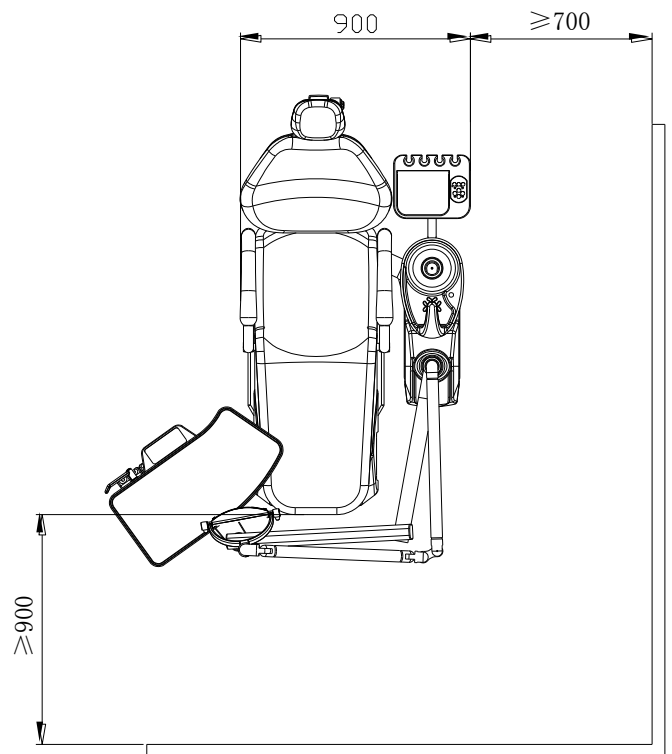

II. Product installation

1. Installation handling

Unpack the product, take out the power cord and connect to a power supply.

Raise the dental patient chair to the top, remove the front and bottom housing, and unplug the power cord.

Use M10 outer hex screws to fix the patient chair and pack it.

Take out the six screws from the bottom plate, and carefully transfer the dental patient chair to the given mounting position.

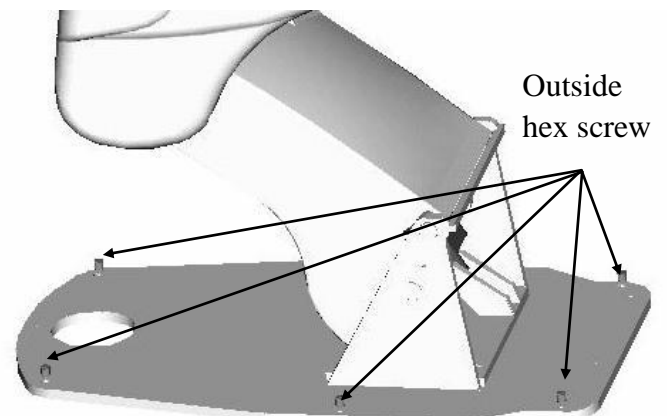

Attention:

☞ In your handling of the product, don't lift the rotary arm, handrails, assistant rack, box, plastic shell or other fragile parts, so as to prevent them from damage under excessive force in transfer!

☞ **In your transfer, stabilize the tool tray to prevent it from arbitrary turning and touching other object!**



2. Connecting dental unit to patient chair

Handling personnel lift the dental unit to make its pipe hole is 100mm away from patient chair interface. Installer shall put the pipes at the patient chair interface into the port of the dental unit (connect the pipes as per code); use three M10 inner hex screws to fit the unit to the patient chair.

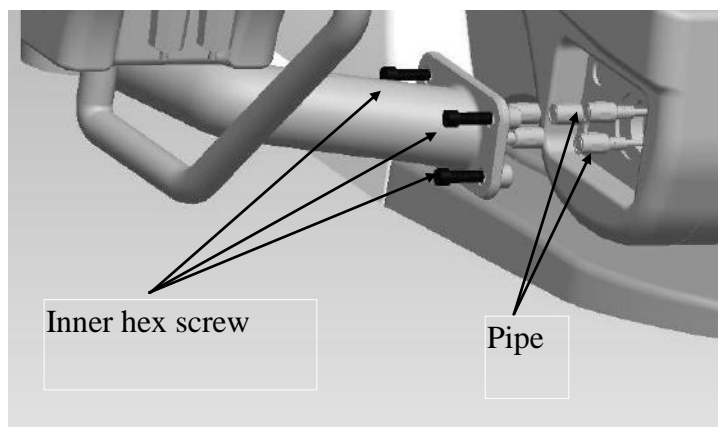

3. Installation of patient chair backrest

Use four M10 inner hex screws to fit the backrest to the patient chair.

Attention:

☞ **Prevent sharp object from scratching backrest skin in the installation process!**

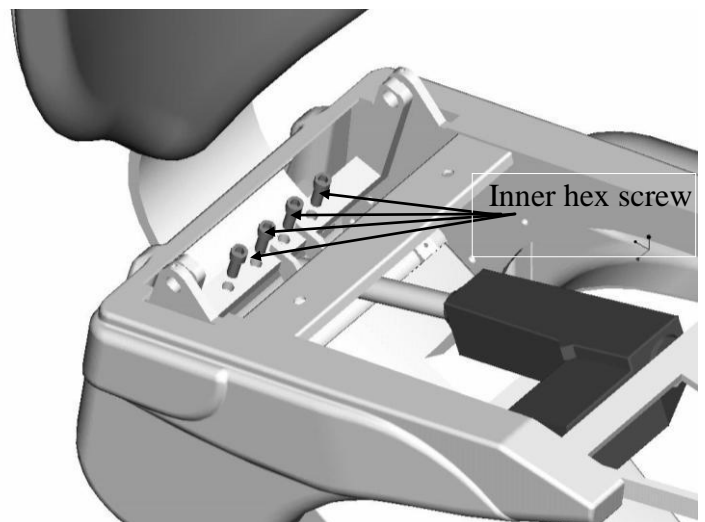

4. Installation of patient chair cushion

Take out three screws from the cushion, pass them through 3 holes on the patient chair, then screw the cushion and fasten the hex screws. In this process, prevent sharp object from scratching backrest skin.

Attention:

☞ **Prevent sharp object from scratching backrest skin in the installation process!**

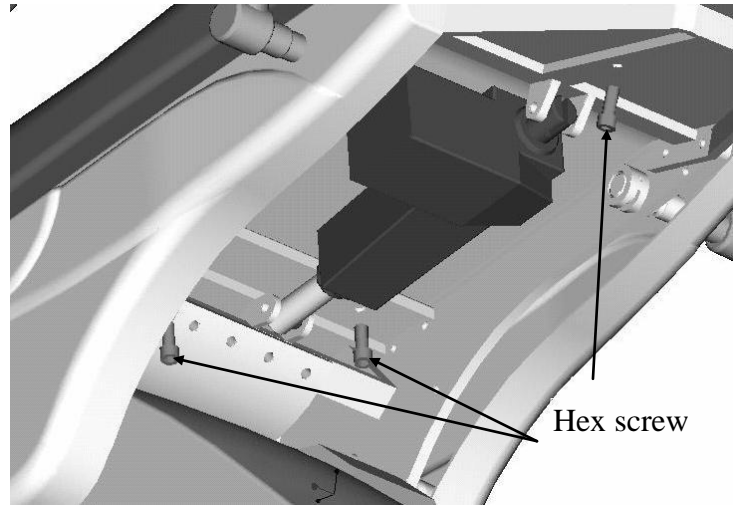

5. Installation of cushion housing

Take out the cushion housing, align it and then take 4 tapping screws and screw them in the seat cushion base.

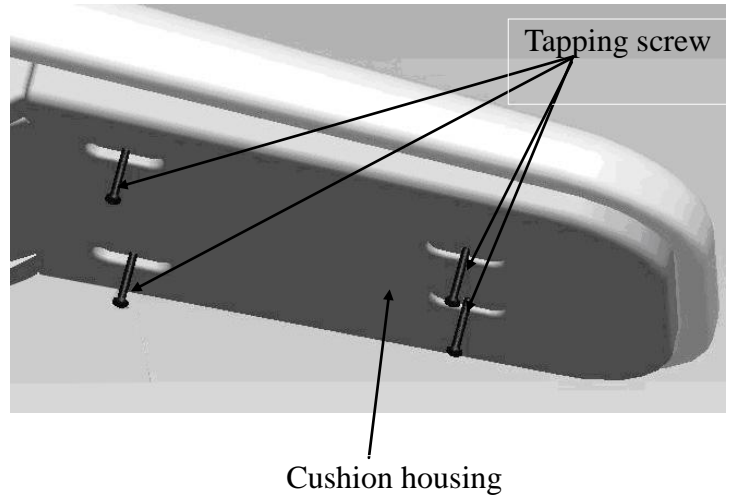

6. Mouth lamp installation

Open the lamp arm box, as shown in Fig.1, install the lamp arm in sequence.

Take out the oral cold-light lamp and unscrew the M5 inner hex screw from the connecting shaft, as shown in Fig.2; sleeve the decorative ring out of the lamp arm connecting shaft; connect the power plugs of the cold-light lamp connecting axle and lamp arm connecting axle; and plug the power cord and plug into the lamp arm axle, then insert the cold-light lamp connecting axle into the lamp arm axle, and fasten them with attached M5X12 bolts.

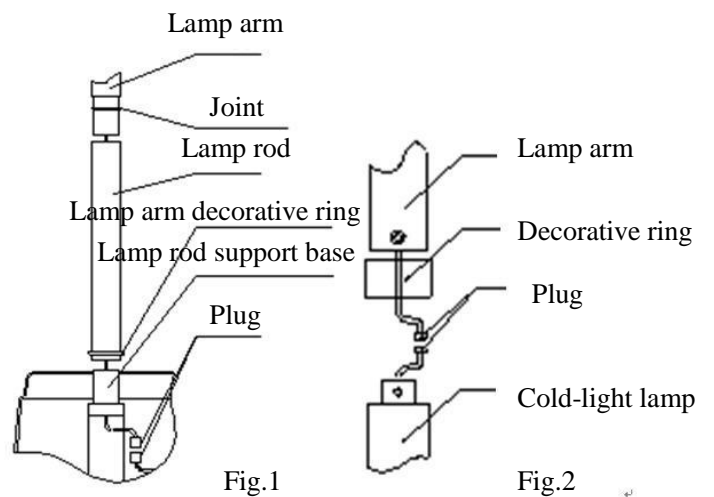

7. Installation of water and air pipes of floor tank

Connect the water and air inlet pipes and drainage pipe of the unit to water and air source and drain port respectively; in connection, keep the water and air pipe interfaces well sealed to prevent water/ air leak. Connect the earth wire of the unit.

According to the installation position of the unit, lay the water and air inlet pipes and drainage pipe, use ($\phi 8 \times \phi 5$ PVC water and air inlet pipes (i.e. ZG1/2"), connect with elbow; use drainage pipe with inner dia. Greater than 27.5mm, with drain port retained. See the installation figure at the right.

Attention:

☞ 1. The drain port height shall not exceed the height of patient chair above the floor, other water inside the drain pipe may flow back!

☞ 2. Be sure to lay the drain port in a smooth-flow inclined type.

☞ 3. Be attentive not to make the drain pipe twisted, ups or downs, don't put drain port in water.

8. Horizontality adjustment of apparatus

Screw six attached M12 hex screws into six M12 thread holes at the base plate of the patient chair, adjust the screwing length till the horizontality of the unit.

Attention:

☞ In adjustment, ensure the patient chair base plate contact the ground as much as possible so as to ensure the stability of the apparatus!

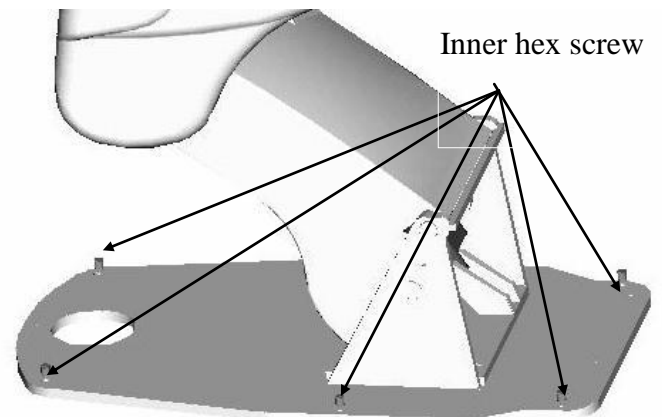
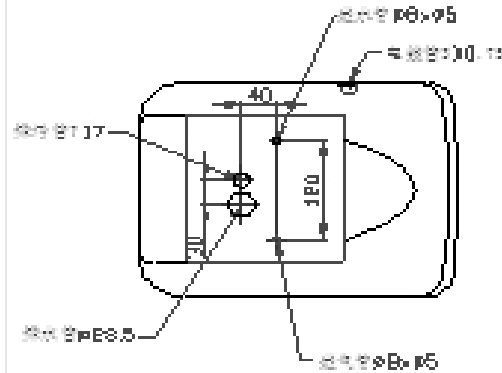
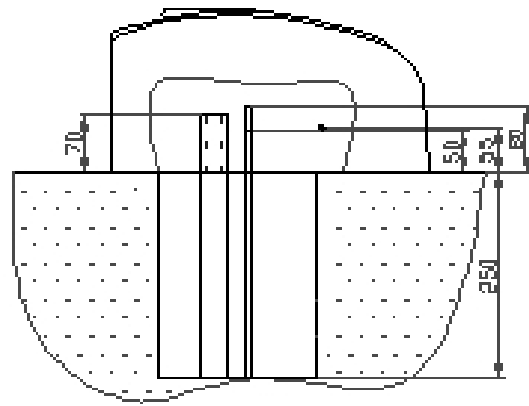

9. Installation of tool tray accessories

a) Installation of three-purpose spray gun

Take out the three-purpose spray gun nozzle from the accessories bag, press down the ring on the gun and insert into the nozzle; then release the ring to make it reset; if the ring is still at pressed state, indicating it's yet to be positioned; press it again and insert the nozzle deeper till the ring bounces out.

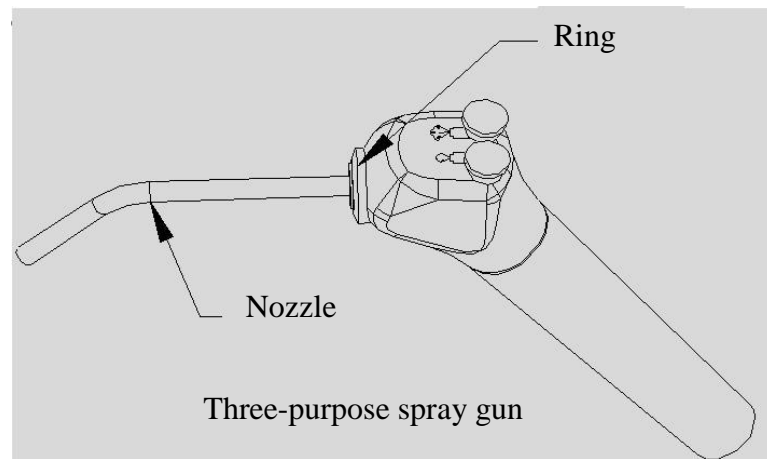

b) Installation of handpiece

Before handpiece installation, turn on the water and air sources, draw out each handpiece hose and step down the foot switch to discharge the water and air residue inside the hoses.

In installation, align with the hole positions and screw in the bolts.

Attention:

☞ **Refer to the User Manual of handpiece for its use, sterilization and maintenance!**

Part 10 Test of Product

1. Buzzer sounds a "beep", the power indicator lights on the tool tray and assistant rack are on, the apparatus has self-checking.
2. Check the water source connector, ensuring it's free from any water leakage.
3. Check the air source connector, ensuring it's free from any air leakage.
4. Check the value indicated on the pressure gauge of the air pressure relief valve, and the normal working pressure is 0.55Mpa. If any error, regulate the regulating knob of the air-filter relief reducing valve to above value. Regulation method: dial up the knob at top of the air-filter pressure relief valve, turn it clockwise to increase the pressure, or turn in the opposite direction to drop the pressure value.

☞ In using the product, ensure water, air and electricity are turned on!

☞ All given parameters have power-off automatic saving function.

☞ When the power is off and then resumes, except the operation undergone is suspended, no safety issue will occur. If work is to continue, turn it on again.

1. Instructions for tool tray button panel

① Patient chair positioning

Press and hold each button respectively, the patient chair will run as indicated on the icon; release the button, the chair stops movement.

— “” indicates the patient chair rise;

— “” indicates the patient chair drop;

— “” indicates the patient chair backrest backward;

— “” indicates the patient chair backrest forward.

② Gargle water supply

Press the “” button, water is supplied from the gargle water outlet to the given time; in the water supply, press the button again to stop water supply.

Refer to the contents of ⑩ Setting buttons for time setting!

③ Spittoon flush

Press the “” button, the spittoon flushes water for three minutes automatically; in the flush period, press the button again to stop flushing.

④ Constant temperature hot water

Press the “” button to start the constant-temperature water heater and heat the water to 40°C; when water temperature drops, the water heater will automatically work (in heating the water, the indicator light flickers; after arriving at the given value, the indicator light keeps on); press the button again to turn off the water heater (indicator light is off).

Attention:

☞ **The hot water is only supplied to gargle water and three-purpose spray gun! (Connect water source before using the water heater to prevent water heater burning dry, causing short circuit.**

⑤ Patient chair reset

Press “RESET” button to drop the patient chair to the lowest position and backrest tilt to the max. front.

Attention:

☞ **In the operation of the patient chair, if any other function button is pressed down, the function of this button will stop automatically!**

⑥ Setting button

a) Gargle water supply time setting

Step 1: Press “SET” button, the indicator lamp is on.

Step 2: Press “” button long to supply water to desired quantity, then release the button.

Step 3: Press “SET” button, the indicator lamp is off, and setting is complete.

Attention:

☞ **This setting procedure is only limited to water supply time. If water pressure changes greatly, water supply amount will change, please re-set it!**

⑦ Pre-setting button

Press the button, the electric dental chair will resume to a pre-set position; press any button to stop the action.

2. Instructions for assistant rack button panel operation

1, 2, 3 and 4 patient chair positioning

5 Gargle water supply

6 Spittoon flush

7. Constant-temp. hot water

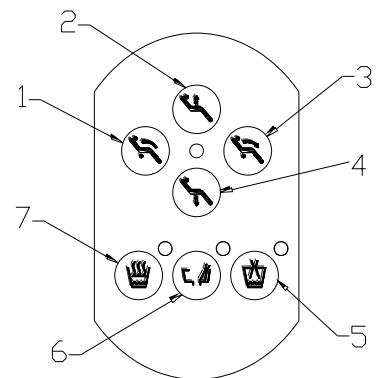

Refer to the “Instructions of assistant rack button panel” for functions of function buttons

3. Instructions for water storage tank

Water in the tank is only used for the apparatuses on the tool tray.

Upon selecting water tank supply, perform the following steps:

Step 1: Press down switch “①” to disconnect the tap water supply.

Step 2: Turn switch “②” to “on” to change tool tray apparatus water source into water tank.

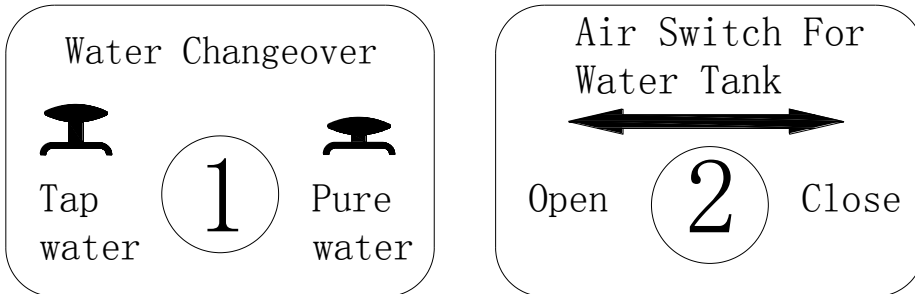

Attention:

☞When using tap water to supply tool tray apparatus, please confirm switch “1” is at the dialed position!

☞When switch “2” is turned from “ON” to “OFF”, it’s normal that air exhaust phenomenon occurs!

4. Instructions for foot controller use

①Patient chair positioning

Push the ball rod to the indicated four directions, and patient chair will move as the icon indication; release the ball rod, it resets automatically and stops patient movement.

- “UP” indicates patient chair rise;
- “DO” indicates patient chair drop;
- “BD” indicates patient chair backrest backward;
- “BU” indicates patient chair backrest frontward

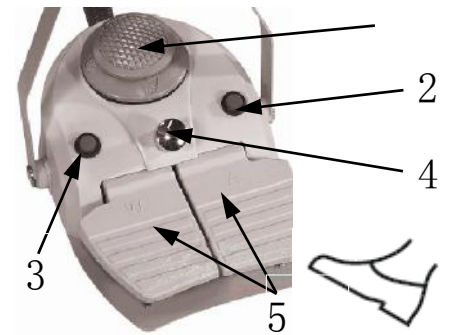

②Gargle water supply (SUPPLY)

Step the button slightly, gargle water outlet supply water to the given time; in the supply period, stepping the button again can stop water supply.

③Spittoon water flush (RUSH)

Step the button slightly, the spittoon flushes water for three minutes before stop; in the flush period, stepping the button again can stop water supply.

④ Chip blow button (BLOW)

At handpiece completes working, step the button to blow dry the water residue inside the handpiece pipe.

Attention:

☞ **Chip blow capacity can be adjusted as you require! (Refer to “Instructions for water and air quantity adjustment of handpiece”).**

⑤ Handpiece working pedal

Left pedal “W” indicates handpiece working water source control switch; right pedal “A” indicates handpiece working air source control switch. The operation method is:

- When only left pedal is stepped, only handpiece water source works;
- When only right pedal is stepped, only handpiece air source works;
- When both left and right pedals are stepped, the handpiece water and air sources work concurrently.

Attention:

☞ **Please don't draw out two or three handpieces for use concurrently!**

☞ **Handpiece holder is equipped with automatic locking device. Upon using the handpiece, draw it out of the holder!**

5. Instructions for water and air quantity adjustment of handpiece

Handpiece air adjustment symbol is given in Fig.1, and hand piece water adjustment symbol is given in Fig.2.

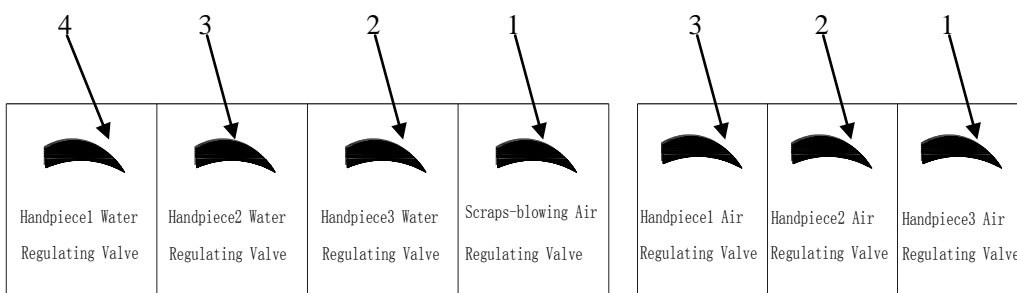

Fig.1

Fig.2



Fig.3

a) Items ①, ② and ③ given in Fig.1 and Fig.2 correspond with items ①, ② and ③ working water and air quantity of handpiece in Fig.3. The adjustment method is: connect three handpieces, as shown in figure; draw out any one handpiece and step down the two pedals of pedal controller, then turn to adjust water and air quantity as



indicated by the knobs on Fig.1 and Fig.2.

Air quantity can be observed through the handpiece manometer on the tool tray, and water quantity is decided by eye observation.

b) Item ④ of Fig.1 is used to adjust the handpiece’s chip blow air quantity, and air quantity can be adjusted by turning the symbol indication knob.

Attention:

☞ **Please don’t draw out two or three handpieces for adjustment concurrently!**

6. Instructions for cold-light lamp use

Cold-light lamp symbols are given in the right figure:

- ① Strong light
- ② Light off
- ③ Weak light

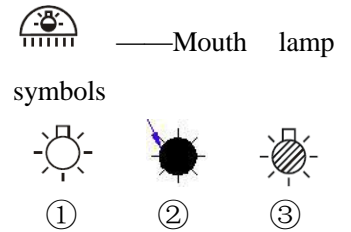

Attention:

☞ **Power of cold-light lamp is controllable with tool tray button!**

7. Instructions of film-viewing lamp

As shown in the figure, turn the switch at a side of the film-viewing lamp to "ON" to turn it on, or turn to "OFF" to turn it off.

Attention:

☞ **Power of film-viewing lamp is controllable with tool tray button!**

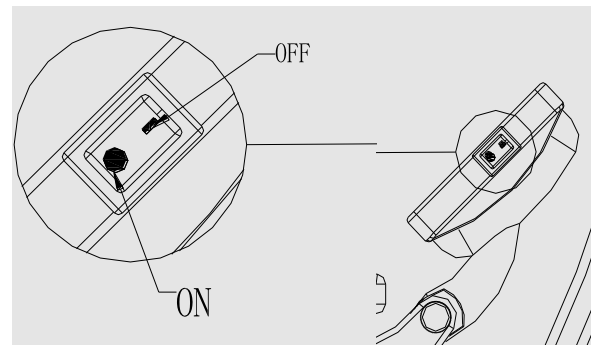



8. Instructions of three-purpose spray gun and saliva sucker

① Three-purpose spray gun

— Press down “” button to spray water only;

— Press down “” button to spray air only;

— Press down “” and “” concurrently to spray mist.

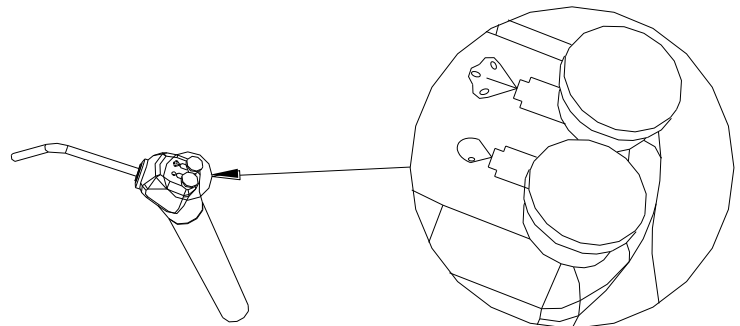

① Saliva sucker

Take off the strong and weak suckers from the assistant rack, it starts automatic suction.

Part 12 Maintenance

1. To ensure product clean, often clean the product surface with medical alcohol (as shown in the figure)

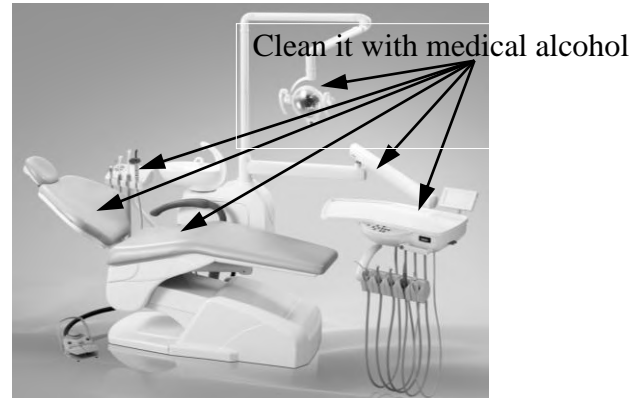

2. To keep the good state of active parts of the product, periodically apply lubricant to the turning parts. It's suggested to be done at least once a year.

3. To keep the cleanliness of tap water clean, periodically clean with neutral detergent the filter of the floor water tank (filter spec. is less than $50\mu\text{m}$). It's suggested to be done at least on six-month basis. If water filter casing or filter is found damaged, replace it immediately.

4. To maintain the cleanliness of the water storage tank, periodically clean the inside of the tank with neutral detergent, it's suggested to be done at least once a week. Before removing the water storage tank, please disconnect the air source switch of the tank.

5. To keep the air dry, periodically exhaust the water inside the air pressure relief valve (filter size smaller than $5\mu\text{m}$), it's suggested once a week. Upon finding the air pressure relief valve leakage, replace it immediately.

6. Mouth lamp maintenance shall be done in room temperature, i.e. cleaning the surface with wet soft cloth. Cleaning of the reflective surface shall be done by blowing with compressed air.

7. Saliva suction filter, after used for a time, is liable to solid dirt, then it shall be removed periodically to be cleaned with clean water, it's suggested to clean after each day off.

8. Refer to other instructions for handpiece maintenance and sterilization before use.

Part 13 Troubleshooting

Failure	Reasons Analysis	Troubleshooting	Remark
Mouth lamp is not on	<ol style="list-style-type: none"> 1. Bulb is burnt; 2. Film is in poor contact; 3. Plugs are in poor contact; 4. Power transformer secondary side fuse burnt; 5. Wire inside active joints is broken. 	<ol style="list-style-type: none"> 1. Replace with a bulb of same size; 2. Correct with a tool and plug in; 3. Replace with fuse of same size; 4. Replace with a new wire. 	
Gargle water supply can not be closed	<ol style="list-style-type: none"> 1. Impurities block the electromagnetic valve core 	<ol style="list-style-type: none"> 1. Remove valve core for cleaning 	
Gargle water can't supply	<ol style="list-style-type: none"> 1. Water pipe twisted or pinched; 2. Solenoid valve coil burnout. 	<ol style="list-style-type: none"> 1. Make it smooth or replace it; 2. Replace the solenoid valve. 	
Gargle water is too high	<ol style="list-style-type: none"> 1. A temperature relay inside the water heater hood fails; 2. Thermostat temperature too high. 	<ol style="list-style-type: none"> 1, Replace with new water heater; 2. Regulate temperature again. 	
Poor spittoon water discharge	<ol style="list-style-type: none"> 1. Dirt inside pipe blocks; 2. Plastic pipe is pressed flat. 	<ol style="list-style-type: none"> 1. Remove dirt; 2. Remove it and soak into hot water to recover it, or replace with a new pipe. 	
spittoon water can't discharge	<ol style="list-style-type: none"> 1. Water pipe twisted or pinched; 2. Solenoid valve coil burnout. 	<ol style="list-style-type: none"> 1. Make it smooth or replace it; 2. Replace the solenoid valve. 	
Saliva suction is poor	<ol style="list-style-type: none"> 1. Dirt inside pipe blocks; 2. Dirt inside filter blocks. 	<ol style="list-style-type: none"> 1. Suck clean water for cleaning or remove and clean it; 2. Remove the filter for cleaning and then restore it. 	

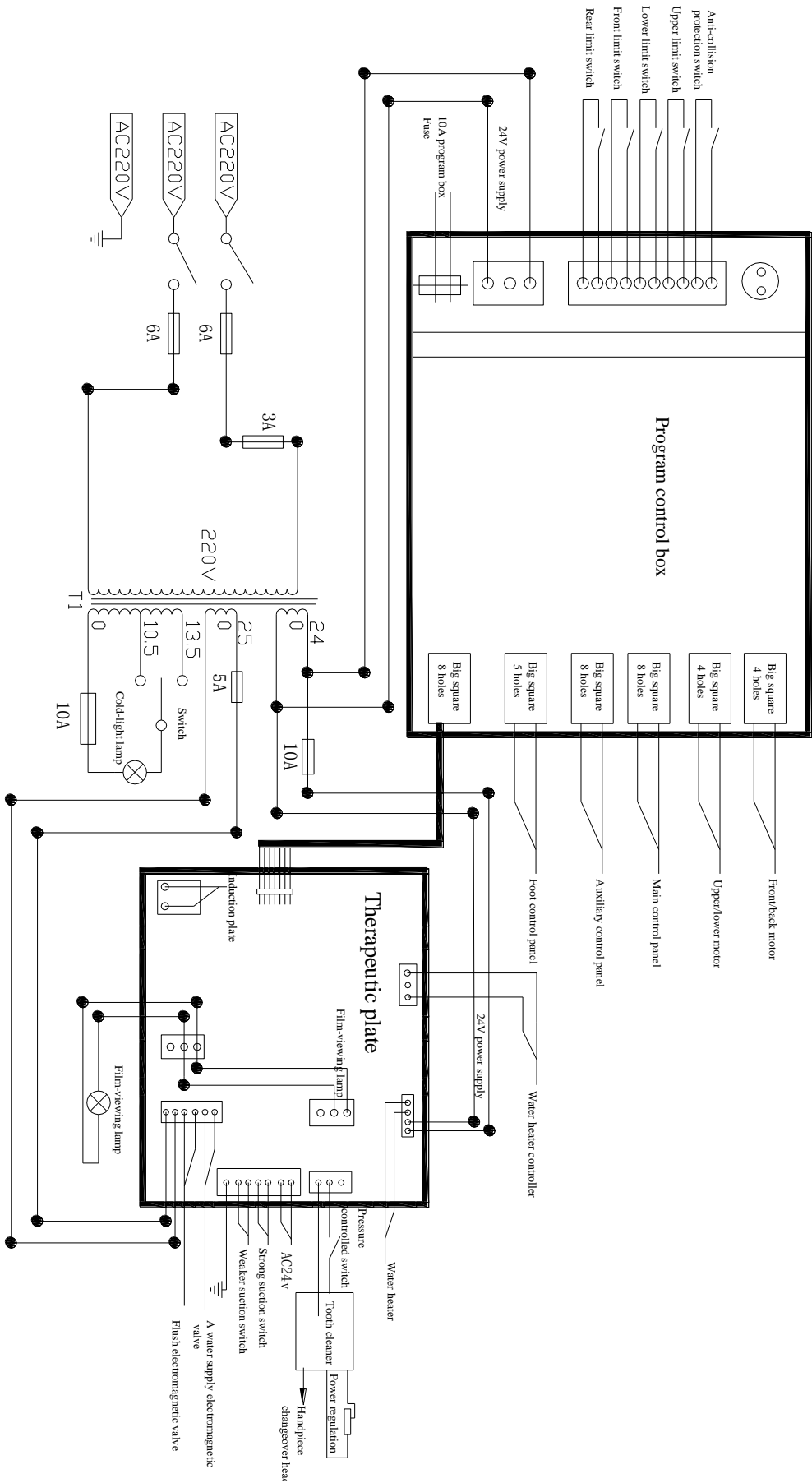

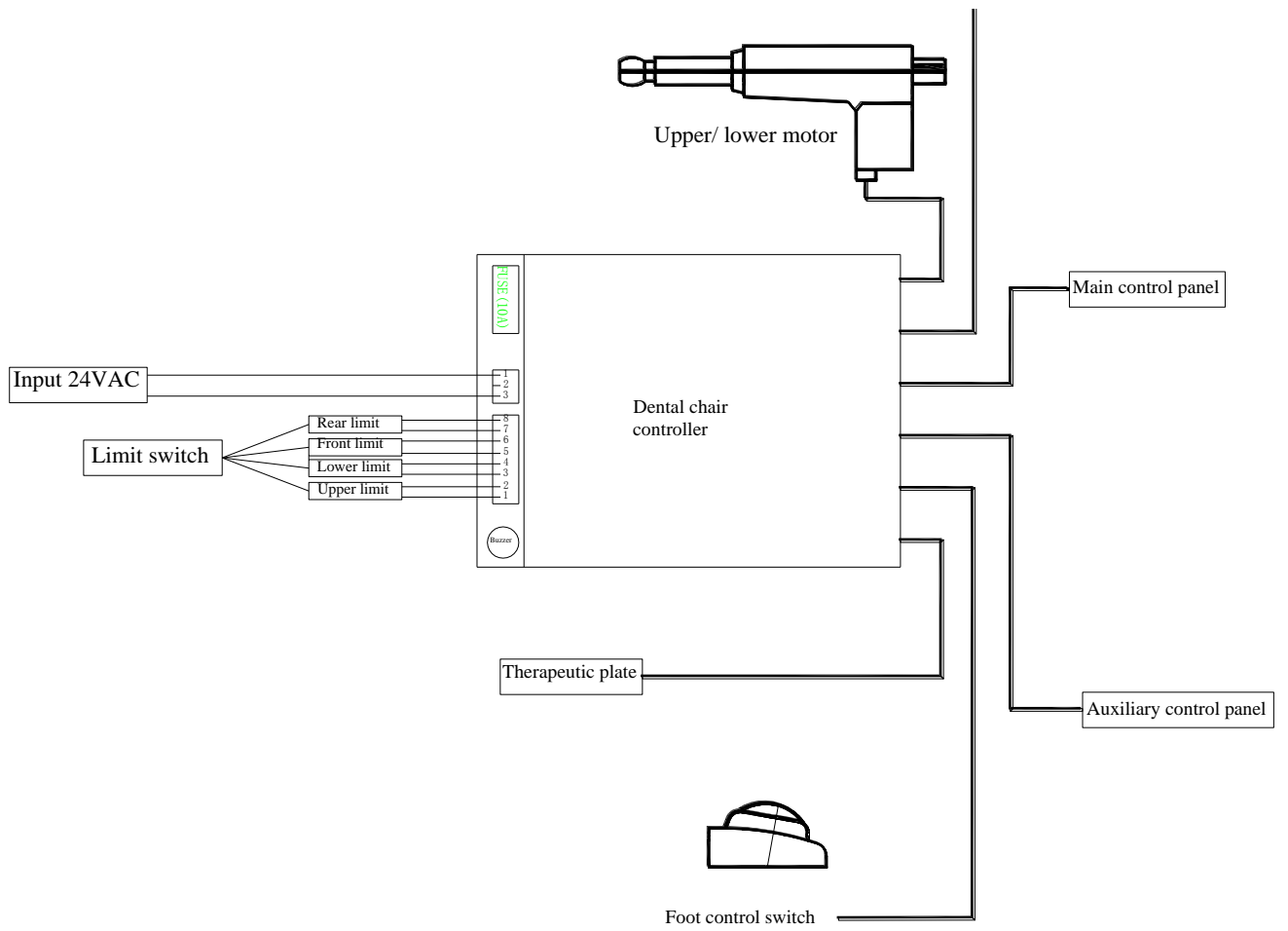

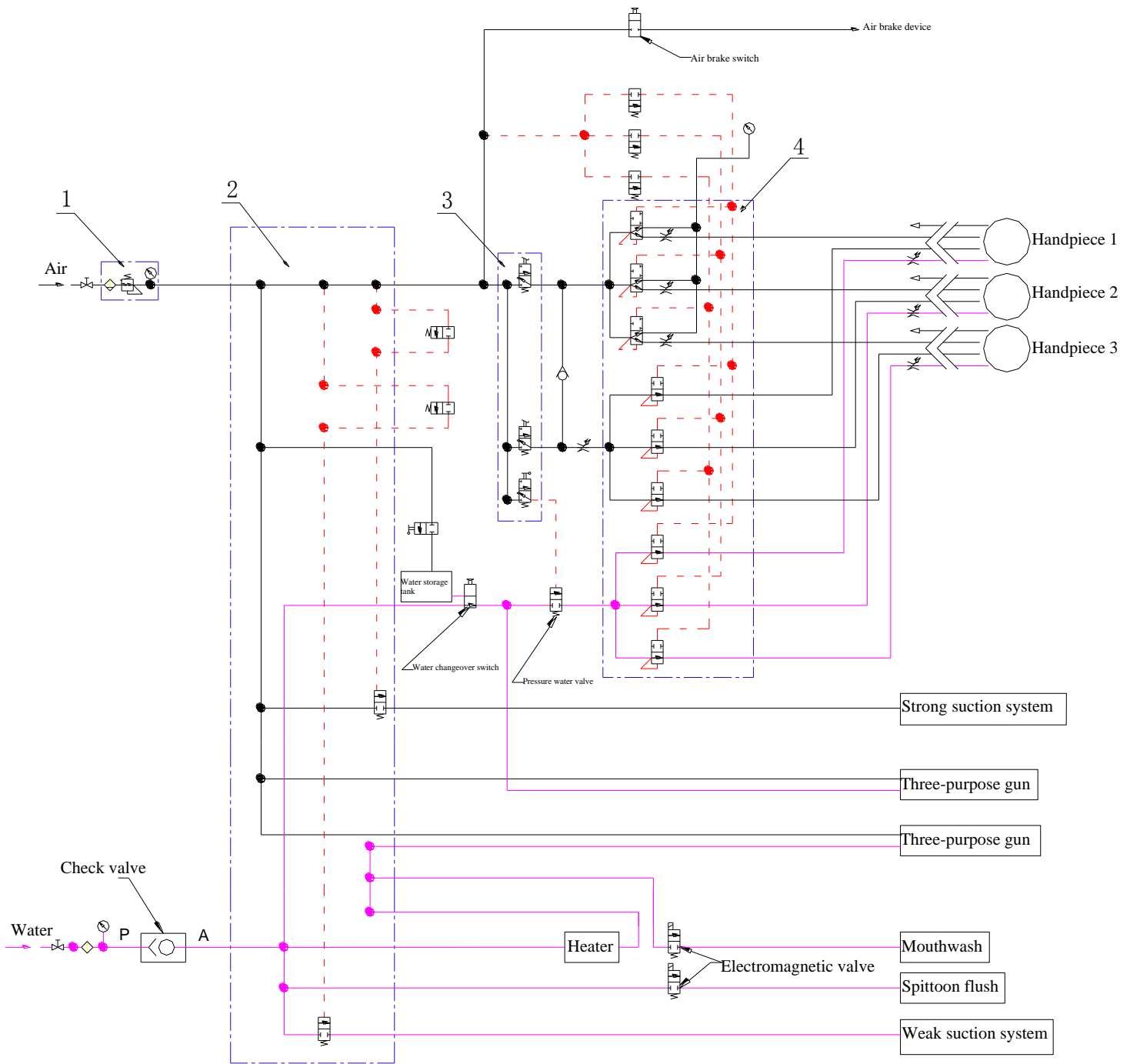

1. Air-filter pressure relief valve 2. Box integrated valve 3. Foot switch
 4. Apparatus bench integrated valve 5. Hanging valve

Part 17 Schematic Diagram for Water & Air Routes

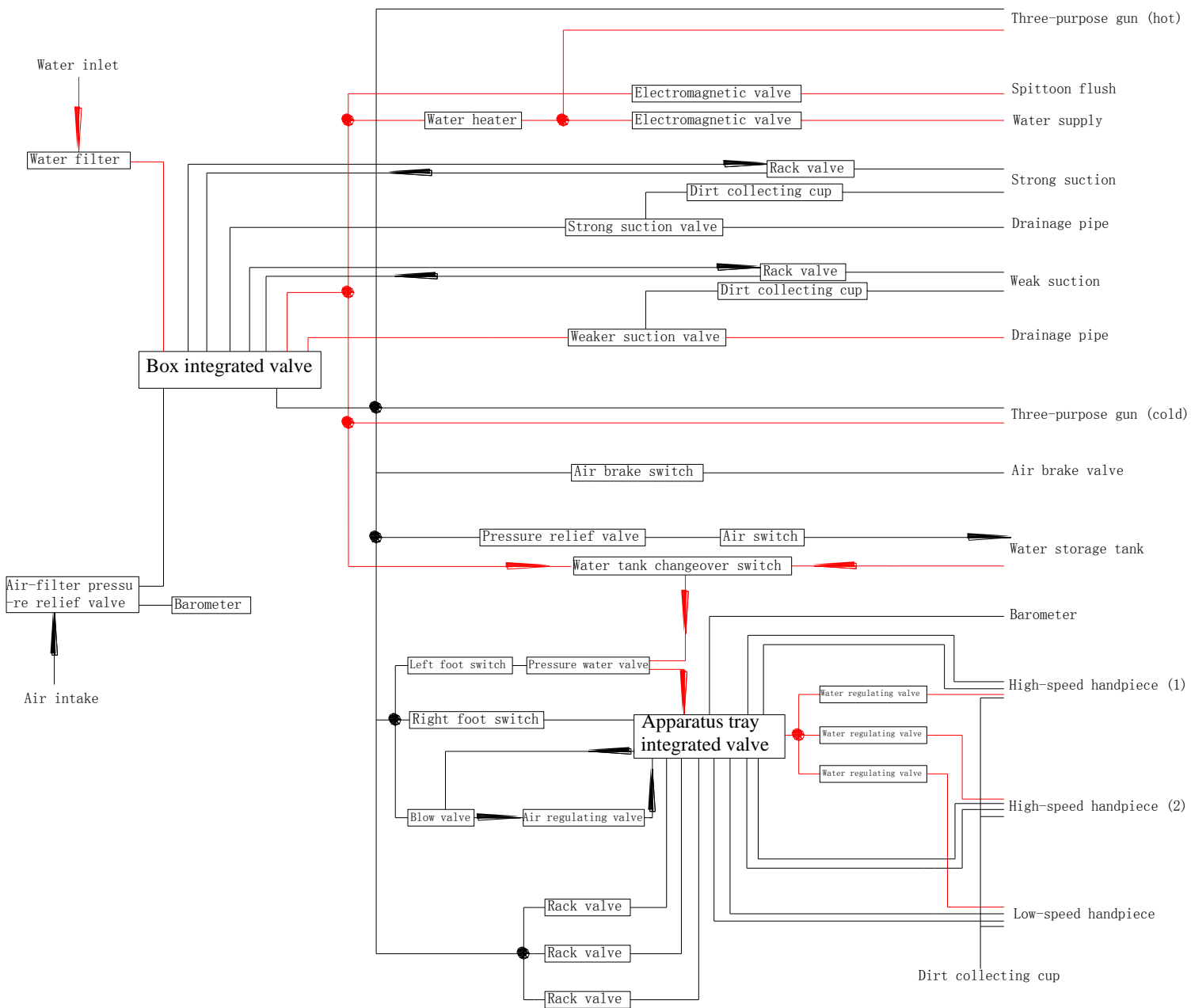

Note: Water pressure of the above water and air elements shall not exceed 0.4MPa, and air pressure shall not exceed 0.8MPa.